



Tubes Radiogènes à Anode Tournante
 Röntgenröhre mit rotierender Anode
 Tubos de Rayos-X con Ánodo Giratorio

Note: Document originally drafted in the English language.

Product Description	Description du Produit	Produktbeschreibung	Descripcion del Producto
<p>The G-1582BI-G is a 5.25" (133 mm) 125 kV, 1.1 MJ (1.5 MHU) maximum anode heat content, rotating anode insert. This metal center section insert is designed for radiography, cineradiography, digital and film screen angiography procedures. The insert features a 10° rhenium-tungsten facing on molybdenum with a graphite backed target and is available with the following nominal focal spots:</p>	<p>Le tube G-1582BI-G, à anode tournante de 133 mm, (5,25 pouces), 125 kV, avec une capacité calorifique maximale de 1,1 MJ (1,5 MUC). Cette section métallique centrale a été conçue pour les procédures radiographiques, cinéradiographiques numérisés et sur film. L'tube est pourvu d'une anode avec pente de 10° en rhénium - tungstène sur une base de molybdène et avec un doublage de graphite. Il est disponible avec les combinaisons foyers suivantes:</p>	<p>Die G-1582BI-G ist eine 5.25" (133 mm) Doppelfokus Drehanoden-Röntgenröhre, mit einer Anoden Wärmespeicherkapazität von 1.1 MJ (1.5 MHU) und einer max. Spannungsfestigkeit von 125 kV. Diese Einsatz mit metallischem Mittelteil wurde für Radiographie-, Röntgenkinematographie-, digitale und Filmangiographieverfahren entwickelt. Der rückseitig graphitbeschichtete Rhenium-Wolfram- und Molybdän Anodenteller besitzt einen Winkel von 10°. Folgende Brennfleckkombination ist lieferbar:</p>	<p>El G-1582BI-G es un tubo de ánodo giratorio de 133 mm (5.25"), 125 kV, 1.1 MJ (1.5 MUC). Este tubo de metal en la parte central es diseñado específicamente para radiografía, cineradiográfica, digital, y procedimientos de angiografía con película de pantalla. El blanco emisor es una combinación de renio, tungsteno y molibdeno con grafito en la parte posterior con un rayo central de 10 grados. Disponible con las siguientes combinaciones de marcas focales:</p>
<p>0.3 - 0.6 - 1.0 IEC 60336</p>	<p>0,3 - 0,6 - 1,0 CEI 60336</p>	<p>0.3 - 0.6 - 1.0 IEC 60336</p>	<p>0.3 - 0.6 - 1.0 IEC 60336</p>
<p>Nominal Anode Input Power</p>	<p>Puissance anodique nominale de l'anode</p>	<p>Nominale Anodenbezugsleistung</p>	<p>Potencia nominal de entrada del anodo</p>
<p>Small - 18 kW IEC 60613 Intermediate - 60 kW IEC 60613 Large - 112 kW IEC 60613</p>	<p>Petit foyer - 18 kW CEI 60613 Moyen foyer - 60 kW CEI 60613 Grand foyer - 112 kW CEI 60613</p>	<p>Klein - 18 kW IEC 60613 Mitte - 60 kW IEC 60613 Gross - 112 kW IEC 60613</p>	<p>Foco fine - 18 kW IEC 60613 Intermedio fine - 60 kW IEC 60613 Foco grueso - 112 kW IEC 60613</p>
<p>For the equivalent anode input power of 250 Watts</p>	<p>Pour la puissance anodique d'équivalente thermique de 250 Watts</p>	<p>Gilt bei einer Aquivalent - Anodenleistung von 250 Watt</p>	<p>Para una potencia equivalente del anodo de 250 W</p>
<p>(G-1582BI-G = Any 2 focal spot combinations.)</p>	<p>(L'G-1582BI-G = deux plusieurs combinaisons focales.)</p>	<p>(Die G-1582BI-G = Zwei vercheid-edn Brennfleckkombinationen.)</p>	<p>(El G-1582BI-G = Dos varios combinacion de marcas focales.)</p>
<p>G-1582BI-G models have grid control capability.</p>	<p>Les Modèles G-1582BI-G ont une fonction de commande de grille.</p>	<p>Modell G-1582BI-G ist mit einer Fähigkeit Gittersteuerungsfunktion ausgestattet.</p>	<p>El modelo G-1582BI-G tiene capacidad para de rejillas controlar los electrones.</p>
<p>Grid Control Voltages: Typical Bias Voltage for Cutoff: at 125 kV -3000 Vdc</p>	<p>Potentiél de controle de grille: Voltage typique pour coupure et 125 kV..... -3000Vcc</p>	<p>Gittersteuerspannungen: Typische Vorspannung für Abschaltung bei 125 kV -3000Vdc</p>	<p>Voltaje de rejillas Controlada: Voltaje controlado típico con interruptor a 125 kV -3000Vdc</p>
<p>Grid Voltage for Exposure 0 Vdc</p>	<p>Voltage de grille pendiente exposition 0 Vcc</p>	<p>Gitterspannung für Belichtung 0 dc</p>	<p>Voltaje de rejillas con exponición 0 dc</p>
<p>Note: 1.0 focal spot limited to 90kV with grid control</p>	<p>Remarque: L'1.0 focal suivante est limitée par le 90kV du fonction controle de grille.</p>	<p>Anmerkung: Der Brennfleck 1.0 mit Gittersteuerungsfunktion ist beschränken 90kV.</p>	<p>Nota: La operación 1.0 focale limitada por el 90kV de Rejillas Controlada.</p>

Manufactured by Varian Medical Systems
Fabrique par Varian Medical Systems
Hergestellt von Varian Medical Systems
Fabricado por Varian Medical Systems

Specifications subject to change without notice.
Spécifications susceptibles d'être modifiées sans préavis.
Technische Daten ohne Gewähr.
Especificaciones sujetas a cambio sin previo aviso.

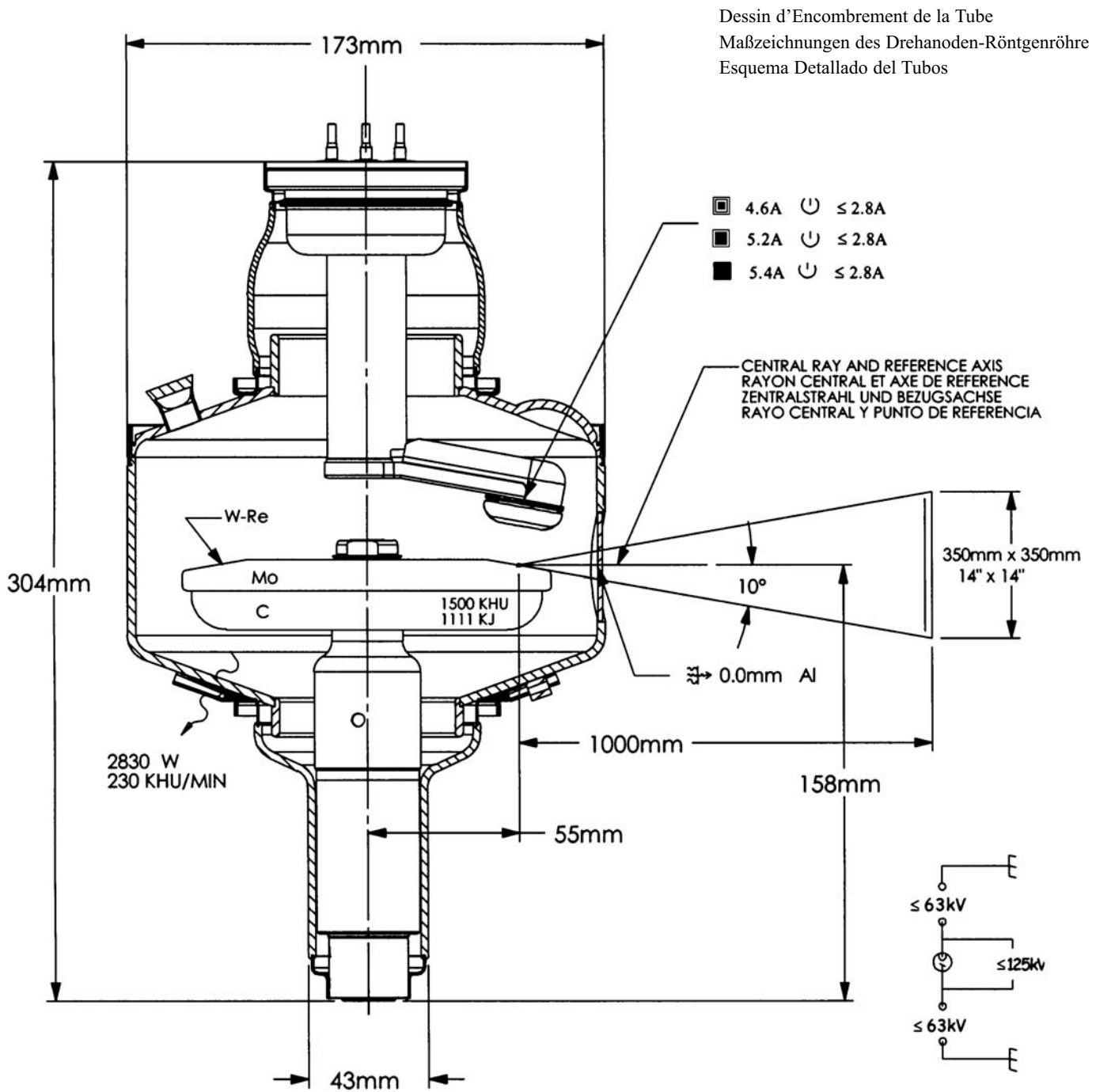

Small - White
Petit - Blanc
Klein - Weiss
Pequeño - Blanco

Large - Black
Grand - Noir
Gross - Schwarz
Largo - Negro

Stand - By
Attente
Bereitschaft
En Espera

X-Ray Tube
Tube Radiogène
Röntgenröhre
Tubo de Rayos X

Intermediate
Moyen
Mitte
Intermedio

Common - Red
Neutre - Rouge
Neutral - Rot
Común - Rojo

Frame or Chasis
Masse
Chassis
Soporte o Chasis

Radiation Filter or Filtration
Filtre de rayonnement
Filterung
Filtración de Radiación

Abaques d'Émissions des Filaments CEI 60613

Heizfadenemissionsdiagramm IEC 60613

Curvas de Emisión de los Filamentos IEC 60613

3 Ø FULL WAVE

THREE PHASE EMISSION ($\pm .15$ A)
G-1582BI-G 0.3

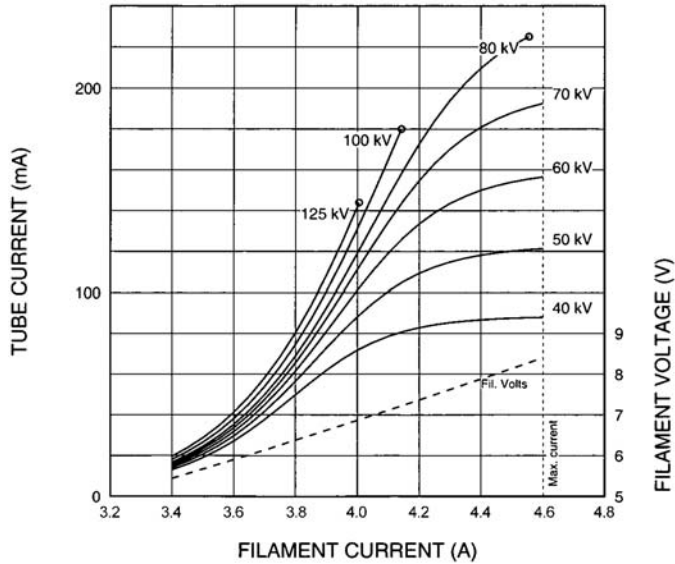

THREE PHASE EMISSION ($\pm .15$ A)
G-1582BI-G 0.6

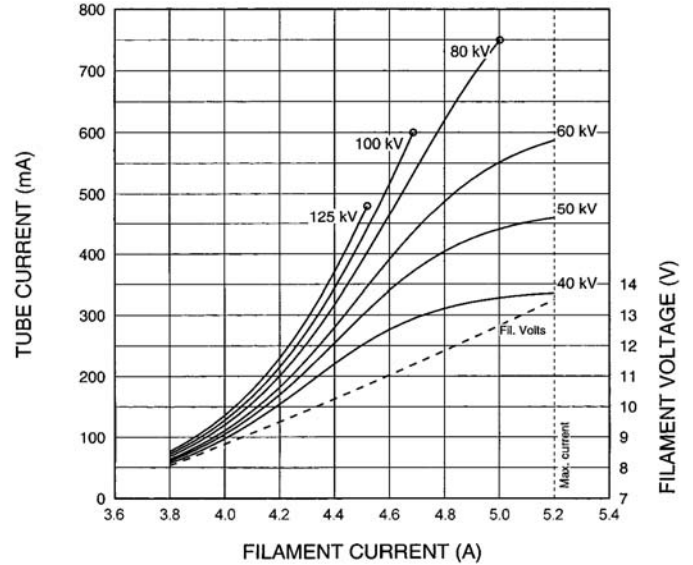

THREE PHASE EMISSION ($\pm .15$ A)
G-1582BI-G 1.0

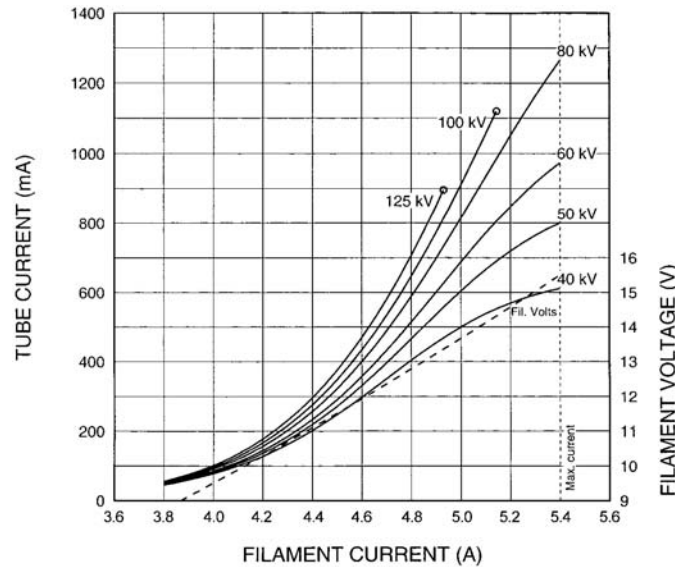

Note: When using these emission curves for trial exposures, refer to the power rating curves shown for maximum kV, tube emission, filament current, exposure time, and target speed.

Remarque: Lors de l'utilisation de ces abaques pour des expositions d'essai, référez-vous aux courbes maximales de kV, d'émission du filament, de temps d'exposition et de vitesse de rotation.

Anmerkung: Wenn Sie diese Emissionskurven für Testaufnahmen verwenden, beziehen Sie sich hierbei auf die entsprechenden Nennleistungskurven für max. kV-Werte, Röhrenemission, Heizstrom, und Anodendrehzahl.

Nota: Si utiliza estas curvas de emisión para exposiciones de prueba, refiérase a las curvas de gradación de potencia para el máximo de kV, tubo de emisión, corriente en los filamentos, tiempo de exposición, y a las curvas de velocidad del objetivo.

Abaques de Charge pour Pose Unique CEI 60613

Brennfleck Belastungskurven IEC 60613

Diagramas de Exposición Radiográfica IEC 60613

50 HZ 3 Ø Constant Potential 60 HZ

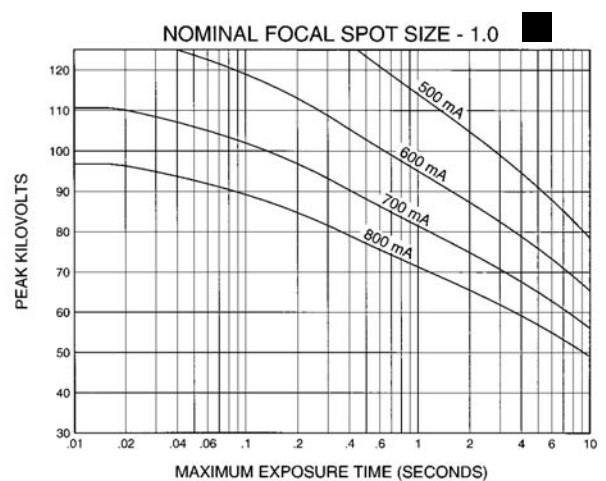
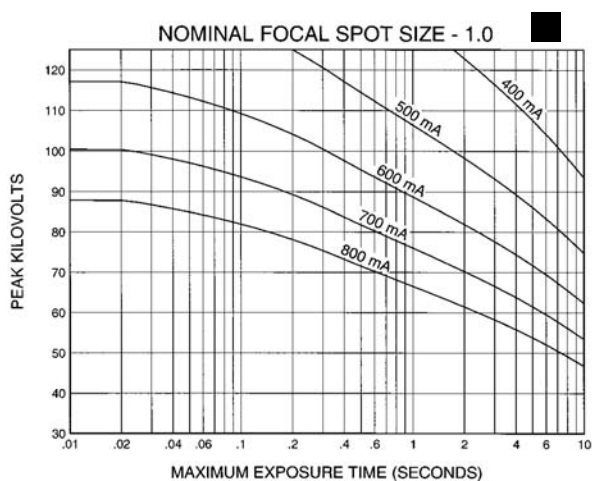
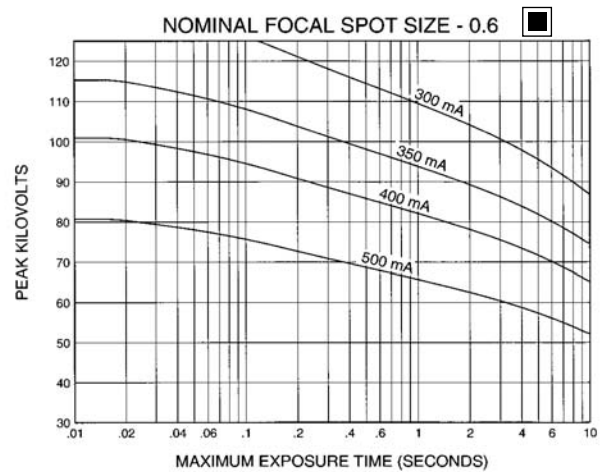
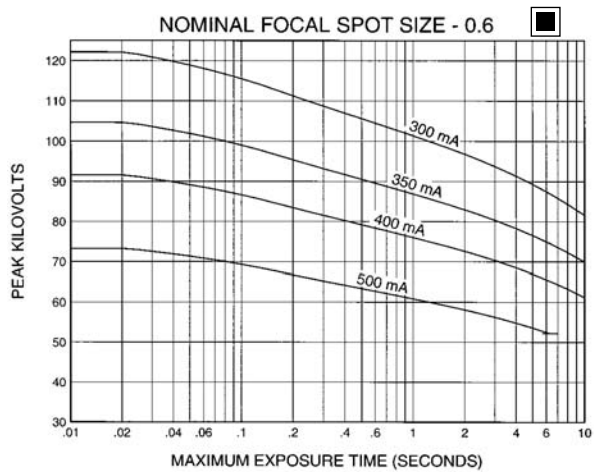
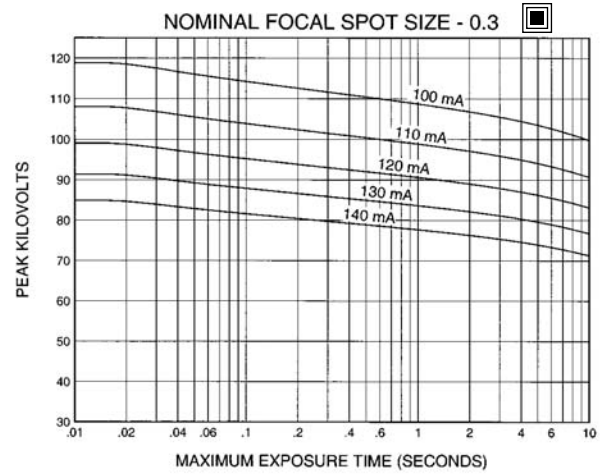
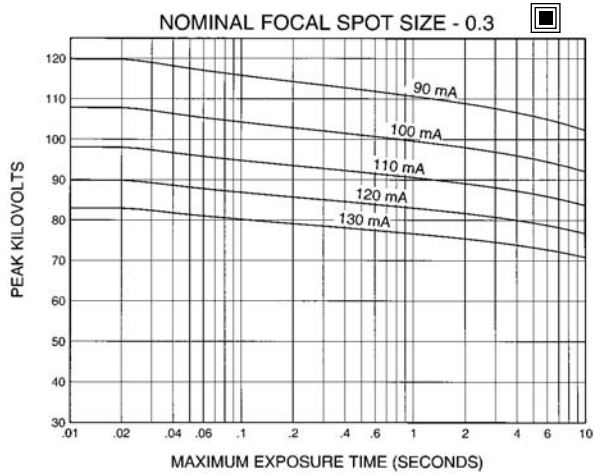

Nominal anode input power for the anode heat content 40%. IEC 60613

Puissance calorifique nominale de l'anode: 40%, CEI 60613

Thermische Anodenbezugsleistung bei einer Wärmespeicherung von 40%. IEC 60613

Aproximadamente el poder de penetracion para obtener un almacenaje de calor del anodo de 40%. IEC 60613

Abaques de Chargepour Pose Unique CEI 60613

Brennfleck Belastungskurven IEC 60613

Diagramas de Exposición Radiográfica IEC 60613

150 HZ 3 Ø Constant Potential 180 HZ

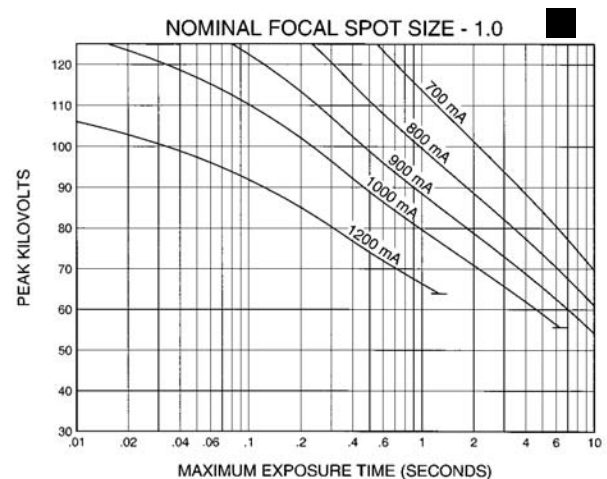
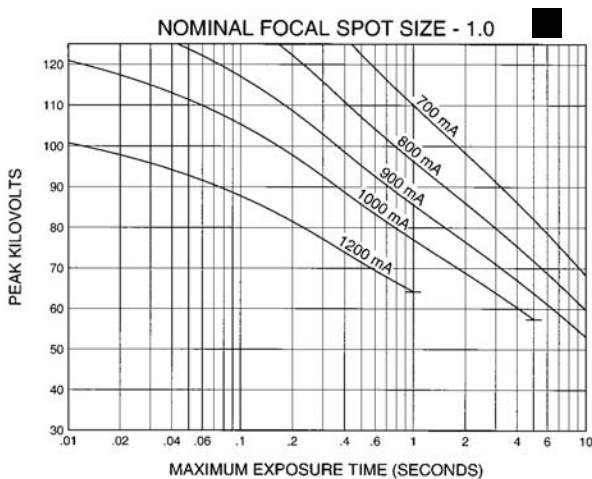
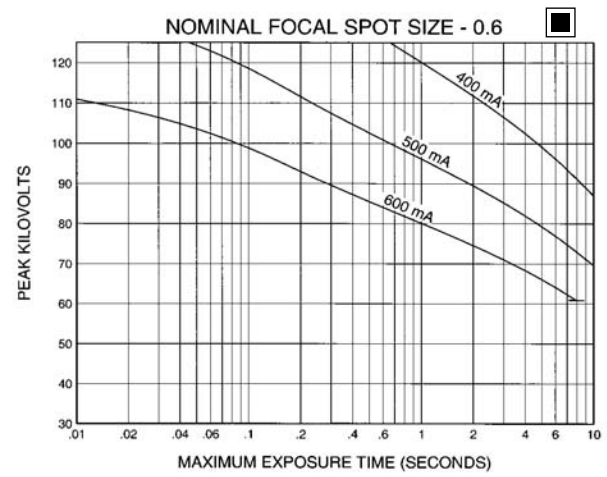
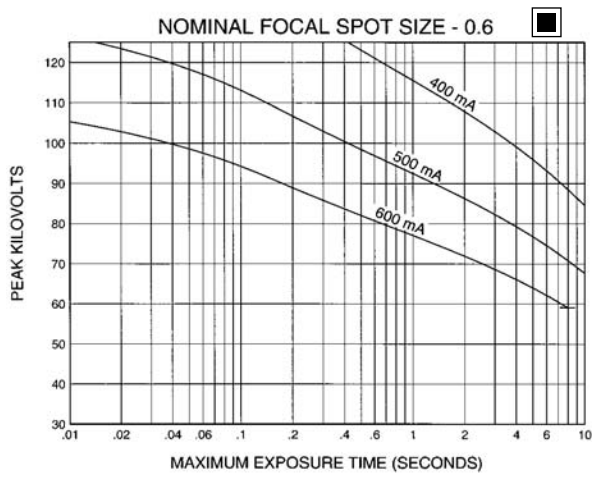
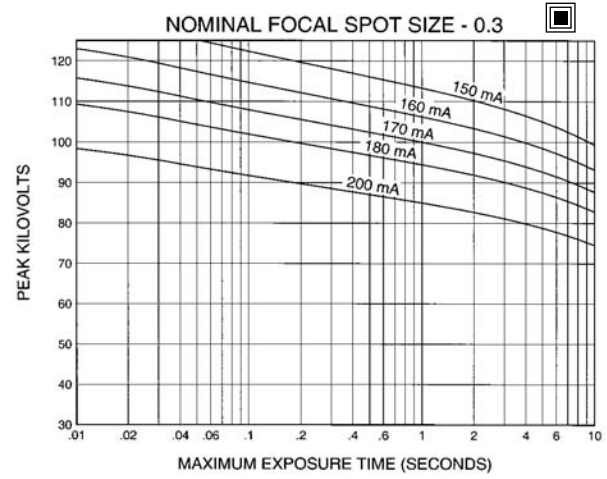
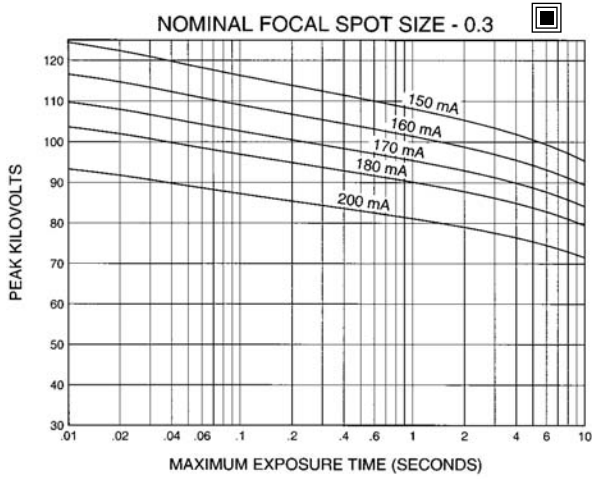

Nominal anode input power for the anode heat content 40%. IEC 60613

Puissance calorifique nominale de l'anode: 40%, CEI 60613

Thermische Anodenbezugsleistung bei einer Wärme speicherung von 40%. IEC 60613

Aproximadamente el poder de penetracion para obtener un almacenaje de calor del anodo de 40%. IEC 60613

CINERADIOGRAPHIC RATINGS

HOW TO USE CINERADIOGRAPHIC CHARTS

General: With the Cineradiographic rating chart we can determine the maximum allowable kW of the Cine pulse, or with a given kW determine maximum time in seconds the cine run can progress.

The Most common way of using the charts is to determine maximum time or any expected Cine run and maximum duty factor. With a known duty factor and Cine run time, kW can easily be determined.

Definition of Terms

Time in seconds: Total time of one Cine run, usually 5 to 12 seconds.

Duty Factor in Percent (DF%): Actual time during one second the x-ray tube is producing x-rays. If we select a 4 msec pulse width and 60 exposures per second the x-ray tube will be producing x-rays for a total of 240 msec each second or 24% of the time. The higher the DF number, the more load placed on the x-ray tube.

Peak Pulse Power: Peak energy in watts of any one Cine Pulse. Can be any combination of kV and mA allowed by Radiographic and Filament Emission curves.

Example: 80 kV at 400 mA equals

$$\frac{80,000 \text{ V} \times 400 \text{ mA}}{1000} = 32,000 \text{ W or } 32 \text{ kW}$$

USING THE CINE RATING CHARTS:

G-1582BI-G 150/180 HZ 3 Phase 1.0 Focal Spot

Example: Determine maximum kW allowed with the following known factors:

Maximum Pulse Width 4 msec

Exposures per Second 60

Maximum Cine Run Time ... 10 seconds

Calculate Duty Factor: (DF%)

$$\text{DF\%} = \frac{\text{Pulse Width (mSec)} \times \text{Frames per Second}}{10}$$

$$\text{DF\%} = \frac{4\text{msec} \times 60 \text{ exp/sec}}{10} = \frac{240}{10} = 24\%$$

Refer to Rating Chart

G-1582BI-G 150/180 HZ 3 Phase 1.0 Focal Spot:

At bottom of chart find 10 second line. Move vertically to intersection with 24% DF curve. Make a horizontal reference to left side of rating chart and note kW rating of 80 kW.

We now know each pulse during the cine run can have a maximum rating of 80 kW under conditions given in example.

kW = kV x mA. The kW of the exposure can be any combination of mA and kV allowed by the Radiographic and Filament Emission Charts.

The Cine rating charts are usable to maximum anode heat content and are based on a starting anode heat content of 70% or less.

Abaques de Cinèradiographie CEI 60613 Belastungskurven für den Kinobetrieb IEC 60613 Diagramas de Exposición Cineradiográfica IEC 60613

3 Ø Constant Potential

50/60 HZ

150/180 HZ

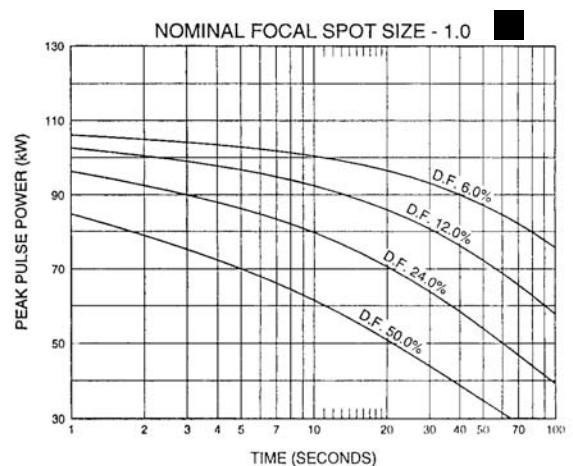
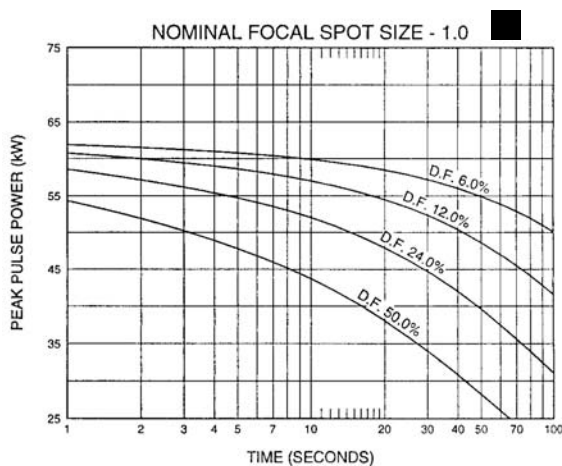
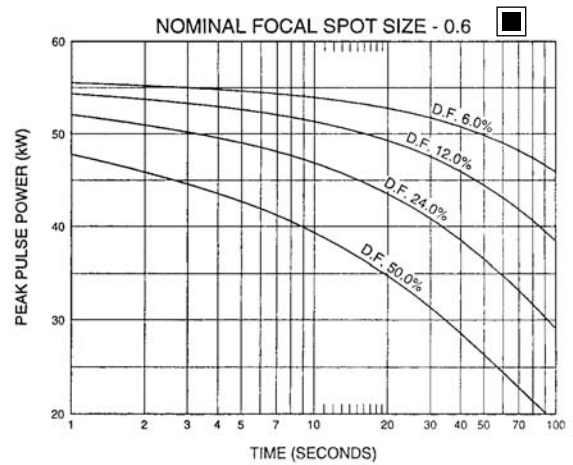
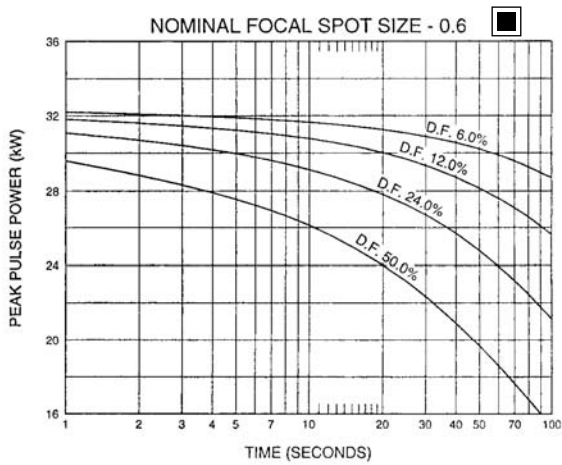
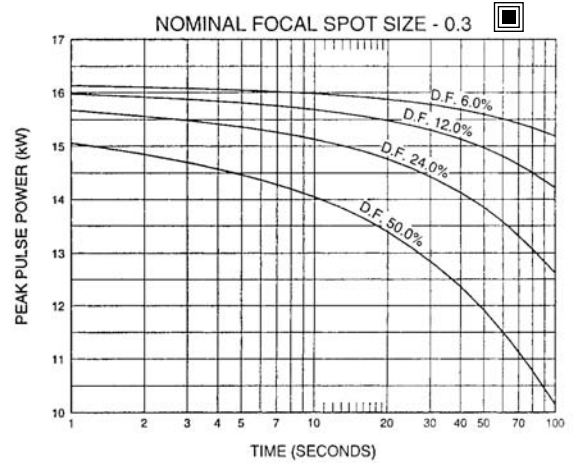
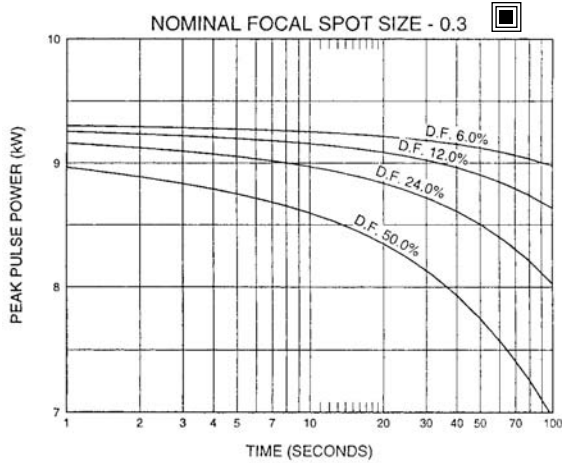

Nominal anode input power for the anode heat content 70%. IEC 60613

Puissance calorifique nominale de l'anode: 70%, CEI 60613

Thermische Anodenbezugsleistung bei einer Wärmespeicherung von 70%. IEC 60613

Aproximadamente el poder de penetración para obtener un almacenaje de calor del anodo de 70%. IEC 60613

ANGIOGRAPHIC RATINGS

HOW TO USE ANGIOGRAPHIC CHARTS

General: Serial Radiography puts a severe demand on the x-ray tube due to the large number of exposures made in rapid succession. Intervals between exposures are fixed and so short that it is not possible for the anode track to cool to any extent during the exposure series. Therefore, the temperature of the anode track increases from exposure to exposure. The kW values used in the angiographic charts have been determined to prevent damage to the anode. The angiographic rating charts are usable to maximum anode heat content.

Definition of Terms

Number of Exposures in Series: The number of exposures made in succession or the number of exposures made during one contrast injection.

Exposure Rate: The number of exposures made per second. For a series of exposures where the exposure rate changes, it must be assumed that all exposures will be made at the maximum rate. For example, if during a series 10 exposures will occur at one per second and 30 exposures at 4 per second, use the kW ratings in the 40 exposure column at 4 per second rate.

Exposure Time: Time in seconds of Each exposure.

USING THE CHARTS:

Select Correct Chart:

0.3, 0.6 or 1.0 Focal Spot

Note: 150/180 HZ rotor speed recommended for all angiography.

Determine the number of exposures in Series: With cut film angiography the number of exposures are known, however in Digital Angiography the number of exposures commonly are not known. When determining the number of exposures, assume worst case or past history.

Note: Most angiographic x-ray tubes fail from underestimating the number of exposures made in a series.

Determine kW of each exposure in Series: Referring to chart —find block under “Number of Exposures in Series” that is greater than or equal to expected number of exposures in Series. On left side directly opposite this block under “Exposure Rate per Second” column, select maximum rate per second that will be used for the exposure series. At the intersection of exposure rate and exposure time in seconds, find maximum kW allowed for each exposure.

For Example: 80 pKV and 500 mA = 40 kW

Example: From chart G-1582BI-G 150/180 HZ 3 Phase

1.0 Focal Spot, determine kW allowed with following known factors.

Maximum number of exposures40
Exposure time .050 second (50 milliseconds)
Maximum Exposure per second4

From chart find 40 exposure block. On left side directly opposite this block under “Exposure Rate per Second” column, select 4 exposures per second. Find .050 seconds at top of chart. At intersection of exposure rate

0.3 Focal Spot 3Ø 10 Degrees 150180 Hz
0,3 Dimension Focale 3Ø 10 Degrés 150/180 Hz
0.3 Brennpunkt 3Ø 10 Grad 150/180 Hz
0.3 De Marcas Focales 3Ø 10 Grados 150/180 Hz

Caractéristiques Pour L'Angiographie CEI 60613
Angiographische Nennleistungen IEC 60613
Gradaciones Angiografica IEC 60613

EXPOSURE RATE PER SECOND	TUBE LOAD (kW) AS A FUNCTION OF THE EXPOSURE TIME (SEC.) OF THE INDIVIDUAL RADIOGRAPHS OF THE SERIES															NUMBER OF EXPOSURES IN SERIES
	0.010	0.020	0.030	0.040	0.050	0.060	0.080	0.100	0.120	0.140	0.160	0.180	0.200	0.225	0.250	
1	15.9	15.6	15.4	15.2	15.1	15.0	14.8	14.7	14.6	14.5	14.4	14.3	14.2	14.1	14.0	10
2	15.9	15.6	15.3	15.2	15.0	14.9	14.7	14.6	14.5	14.4	14.2	14.1	14.1	13.9	13.8	
3	15.9	15.5	15.3	15.1	15.0	14.9	14.7	14.5	14.4	14.2	14.1	14.0	—	—	—	
4	15.8	15.5	15.3	15.1	14.9	14.8	14.6	14.4	14.3	14.1	—	—	—	—	—	
8	15.8	15.4	15.1	14.9	14.7	14.6	14.4	14.3	14.1	—	—	—	—	—	—	
15	15.7	15.3	14.9	14.7	—	—	—	—	—	—	—	—	—	—	—	
30	15.6	15.0	—	—	—	—	—	—	—	—	—	—	—	—	—	
1	15.9	15.5	15.3	15.1	15.0	14.9	14.7	14.5	14.4	14.3	14.2	14.0	13.9	13.8	13.7	20
2	15.8	15.5	15.3	15.1	14.9	14.8	14.6	14.4	14.3	14.1	14.0	13.9	13.7	13.6	13.5	
3	15.8	15.5	15.2	15.0	14.9	14.7	14.5	14.3	14.1	14.0	13.8	13.7	—	—	—	
4	15.8	15.5	15.2	15.0	14.8	14.7	14.4	14.2	14.0	13.8	—	—	—	—	—	
8	15.8	15.3	15.0	14.8	14.6	14.4	—	—	—	—	—	—	—	—	—	
15	15.7	15.2	14.8	14.5	—	—	—	—	—	—	—	—	—	—	—	
30	15.4	14.8	—	—	—	—	—	—	—	—	—	—	—	—	—	
1	15.8	15.5	15.2	15.0	14.9	14.7	14.5	14.3	14.1	13.9	13.8	13.6	13.5	13.3	13.1	40
2	15.8	15.5	15.2	15.0	14.8	14.6	14.4	14.1	13.9	13.7	13.6	13.4	13.2	13.0	12.8	
3	15.8	15.4	15.1	14.9	14.7	14.5	14.3	14.0	13.8	13.6	13.4	13.2	—	—	—	
4	15.8	15.4	15.1	14.8	14.6	14.5	14.1	13.9	13.6	13.4	—	—	—	—	—	
8	15.7	15.2	14.9	14.6	14.4	14.1	—	—	—	—	—	—	—	—	—	
15	15.6	15.0	14.6	14.2	—	—	—	—	—	—	—	—	—	—	—	
30	15.3	14.6	—	—	—	—	—	—	—	—	—	—	—	—	—	
1	15.8	15.4	15.1	14.9	14.7	14.6	14.3	14.0	13.8	13.6	13.4	13.2	13.0	12.8	12.6	60
2	15.8	15.4	15.1	14.8	14.6	14.5	14.2	13.9	13.6	13.4	13.2	13.0	12.8	12.5	12.3	
3	15.8	15.4	15.0	14.8	14.6	14.4	14.0	13.7	13.5	13.2	13.0	12.8	—	—	—	
4	15.7	15.3	15.0	14.7	14.5	14.3	13.9	13.6	13.3	13.0	—	—	—	—	—	
8	15.7	15.2	14.8	14.5	14.2	13.9	—	—	—	—	—	—	—	—	—	
15	15.5	14.9	14.4	14.1	—	—	—	—	—	—	—	—	—	—	—	
30	15.3	14.5	—	—	—	—	—	—	—	—	—	—	—	—	—	
1	15.8	15.4	15.1	14.8	14.6	14.4	14.1	13.8	13.5	13.3	13.1	12.8	12.6	12.4	12.1	80
2	15.7	15.3	15.0	14.7	14.5	14.3	14.0	13.6	13.4	13.1	12.8	12.6	12.4	12.1	11.9	
3	15.7	15.3	14.9	14.7	14.4	14.2	13.8	13.5	13.2	12.9	12.6	12.4	—	—	—	
4	15.7	15.2	14.9	14.6	14.3	14.1	13.7	13.4	13.0	12.7	—	—	—	—	—	
8	15.6	15.1	14.7	14.3	14.0	13.8	—	—	—	—	—	—	—	—	—	
15	15.5	14.8	14.3	13.9	—	—	—	—	—	—	—	—	—	—	—	
30	15.2	14.4	—	—	—	—	—	—	—	—	—	—	—	—	—	
1	15.7	15.3	15.0	14.7	14.5	14.3	13.9	13.6	13.3	13.0	12.7	12.5	12.3	12.0	11.7	100
2	15.7	15.3	14.9	14.6	14.4	14.2	13.8	13.4	13.1	12.8	12.5	12.3	12.0	11.7	11.4	
3	15.7	15.2	14.9	14.6	14.3	14.1	13.6	13.3	12.9	12.6	12.3	12.0	—	—	—	
4	15.7	15.2	14.8	14.5	14.2	14.0	13.5	13.1	12.8	12.4	—	—	—	—	—	
8	15.6	15.0	14.6	14.2	13.9	13.6	—	—	—	—	—	—	—	—	—	
15	15.4	14.8	14.2	13.8	—	—	—	—	—	—	—	—	—	—	—	
30	15.1	14.3	—	—	—	—	—	—	—	—	—	—	—	—	—	
1	15.7	15.2	14.8	14.5	14.2	13.9	13.5	13.0	12.7	12.3	12.0	11.7	11.4	11.1	10.8	150
2	15.6	15.1	14.7	14.4	14.1	13.8	13.3	12.9	12.5	12.1	11.8	11.5	11.2	10.8	10.5	
3	15.6	15.1	14.7	14.3	14.0	13.7	13.2	12.7	12.3	11.9	11.6	11.3	—	—	—	
4	15.6	15.0	14.6	14.2	13.9	13.6	13.1	12.6	12.2	11.8	—	—	—	—	—	
8	15.5	14.9	14.4	13.9	13.6	13.2	—	—	—	—	—	—	—	—	—	
15	15.3	14.6	14.0	13.5	—	—	—	—	—	—	—	—	—	—	—	
30	15.0	14.1	—	—	—	—	—	—	—	—	—	—	—	—	—	

Note:

1. (kW) of Exposure Equals mA x kV.
For Example: 70 kV x 300 mA = 21 kW.
2. Exposures less than .010 seconds will have a kW rating same as .010 seconds.

Remarque:

1. (kW) en exposition égale kV x mA.
Par exemple: 70 kV x 300 mA = 21 kW.
2. Les expositions inférieures à 0.010 sec. ont les mêmes valeurs en kW que celles de 0.010 sec.

Anmerkungen:

1. (kW) der Belichtung ist gleich mA x kV.
Zum Beispiel: 70 kV x 300 mA = 21 kW.
2. Belichtungen von weniger als .010 Sekunden haben die gleichen kW Werte wie die von .010 Sekunden.

Nota:

1. (kW) De exposición se calcula multiplicando mA x kV-por ejemplo: 70 kV x 300 mA = 21 kW.
2. Para exposiciones de menos de .010 segundos, el resultado en (kW) sería lo mismo que el de .010 segundos.

Nominal anode input power for the anode heat content 70%. IEC 60613

Puissance calorifique nominale de l'anode: 70%, CEI 60613

Thermische Anodenbezugsleistung bei einer Wärmespeicherung von 70%. IEC 60613

Aproximadamente el poder de penetración para obtener un almacenaje de calor del anode de 70%. IEC60613

0.6 Focal Spot 3Ø 10 Degrees 150/180 Hz
0,6 Dimension Focale 3Ø 10 Degrés 150/180 Hz
0.6 Brennpunkt 3Ø 10 Grad 150/180 Hz
0.6 De Marcas Focales 3Ø 10 Grados 150/180 Hz

Caractéristiques Pour L'Angiographie CEI 60613
Angiographische Nennleistungen IEC 60613
Gradaciones Angiografica IEC 60613

EXPOSURE RATE PER SECOND	TUBE LOAD (kW) AS A FUNCTION OF THE EXPOSURE TIME (SEC.) OF THE INDIVIDUAL RADIOGRAPHS OF THE SERIES															NUMBER OF EXPOSURES IN SERIES
	0.010	0.020	0.030	0.040	0.050	0.060	0.080	0.100	0.120	0.140	0.160	0.180	0.200	0.225	0.250	
1	53.8	52.3	51.1	50.1	49.3	48.5	47.2	46.0	44.9	44.0	43.1	42.3	41.6	40.8	40.0	10
2	53.7	52.0	50.7	49.6	48.7	47.8	46.3	45.0	43.8	42.7	41.8	40.9	40.1	39.2	38.4	
3	53.6	51.7	50.3	49.1	48.1	47.2	45.5	44.1	42.8	41.6	40.6	39.7	—	—	—	
4	53.4	51.5	50.0	48.7	47.6	46.6	44.8	43.2	41.9	40.7	—	—	—	—	—	
8	52.9	50.4	48.6	47.0	45.6	44.4	—	—	—	—	—	—	—	—	—	
15	52.1	49.1	46.7	44.7	—	—	—	—	—	—	—	—	—	—	—	
30	50.9	47.0	—	—	—	—	—	—	—	—	—	—	—	—	—	
1	53.6	51.9	50.5	49.4	48.4	47.5	45.9	44.5	43.3	42.1	41.1	40.1	39.3	38.3	37.4	20
2	53.5	51.5	50.1	48.8	47.7	46.7	44.9	43.3	41.9	40.7	39.5	38.5	37.6	36.5	35.5	
3	53.3	51.2	49.6	48.2	47.0	45.9	44.0	42.3	40.8	39.4	38.2	37.1	—	—	—	
4	53.1	50.9	49.1	47.7	46.3	45.2	43.1	41.3	39.7	38.3	—	—	—	—	—	
8	52.4	49.6	47.4	45.6	44.0	42.5	—	—	—	—	—	—	—	—	—	
15	51.4	47.9	45.1	42.8	—	—	—	—	—	—	—	—	—	—	—	
30	49.7	45.1	—	—	—	—	—	—	—	—	—	—	—	—	—	
1	53.3	51.2	49.6	48.2	46.9	45.8	43.8	42.1	40.5	39.1	37.8	36.7	35.6	34.4	33.3	40
2	53.1	50.8	49.0	47.5	46.1	44.9	42.7	40.8	39.1	37.6	36.3	35.0	33.9	32.7	31.5	
3	52.8	50.4	48.5	46.8	45.3	44.0	41.7	39.7	37.9	36.3	34.9	33.6	—	—	—	
4	52.6	50.0	47.9	46.2	44.6	43.2	40.7	38.6	36.7	35.1	—	—	—	—	—	
8	51.8	48.6	46.0	43.8	42.0	40.3	—	—	—	—	—	—	—	—	—	
15	50.6	46.5	43.3	40.7	—	—	—	—	—	—	—	—	—	—	—	
30	48.5	43.2	—	—	—	—	—	—	—	—	—	—	—	—	—	
1	52.9	50.5	48.7	47.1	45.6	44.3	42.0	40.0	38.2	36.6	35.2	33.9	32.7	31.4	30.2	60
2	52.7	50.1	48.1	46.3	44.8	43.4	40.9	38.7	36.9	35.2	33.7	32.4	31.1	29.8	28.6	
3	52.4	49.7	47.5	45.6	44.0	42.5	39.8	37.6	35.6	33.9	32.4	31.0	—	—	—	
4	52.2	49.3	47.0	45.0	43.2	41.6	38.9	36.5	34.5	32.7	—	—	—	—	—	
8	51.3	47.7	44.9	42.5	40.5	38.6	—	—	—	—	—	—	—	—	—	
15	50.0	45.6	42.1	39.2	—	—	—	—	—	—	—	—	—	—	—	
30	47.7	41.9	—	—	—	—	—	—	—	—	—	—	—	—	—	
1	52.6	49.9	47.8	46.0	44.4	42.9	40.4	38.1	36.2	34.5	32.9	31.6	30.3	28.9	26.8	80
2	52.3	49.5	47.2	45.3	43.5	42.0	39.2	36.9	34.9	33.1	31.5	30.1	28.9	27.4	26.2	
3	52.1	49.1	46.6	44.6	42.7	41.1	38.2	35.8	33.7	31.9	30.3	28.9	—	—	—	
4	51.8	48.6	46.1	43.9	41.9	40.2	37.3	34.8	32.7	30.8	—	—	—	—	—	
8	50.9	47.0	44.0	41.4	39.2	37.3	—	—	—	—	—	—	—	—	—	
15	49.5	44.8	41.1	38.0	—	—	—	—	—	—	—	—	—	—	—	
30	47.1	41.0	—	—	—	—	—	—	—	—	—	—	—	—	—	
1	52.2	49.3	47.0	45.0	43.2	41.6	38.8	36.5	34.4	32.6	31.0	29.5	26.8	23.8	21.4	100
2	52.0	48.9	46.4	44.3	42.4	40.7	37.8	35.3	33.2	31.3	29.7	28.2	26.8	23.8	21.4	
3	51.7	48.4	45.8	43.5	41.6	39.8	36.8	34.2	32.0	30.2	28.5	27.1	—	—	—	
4	51.5	48.0	45.2	42.9	40.8	39.0	35.8	33.2	31.0	29.1	—	—	—	—	—	
8	50.5	46.4	43.1	40.4	38.1	36.1	—	—	—	—	—	—	—	—	—	
15	49.1	44.1	40.2	37.0	—	—	—	—	—	—	—	—	—	—	—	
30	46.6	40.2	—	—	—	—	—	—	—	—	—	—	—	—	—	
1	51.4	47.9	45.1	42.7	40.6	38.7	35.5	32.9	29.8	25.5	22.3	19.9	17.9	15.9	14.3	150
2	51.2	47.5	44.5	42.0	39.8	37.9	34.6	31.8	29.6	25.5	22.3	19.9	17.9	15.9	14.3	
3	50.9	47.0	43.9	41.3	39.0	37.0	33.7	30.9	28.6	25.5	22.3	19.9	—	—	—	
4	50.7	46.6	43.3	40.6	38.3	36.3	32.8	30.0	27.7	25.5	—	—	—	—	—	
8	49.7	44.9	41.3	38.2	35.7	33.5	—	—	—	—	—	—	—	—	—	
15	48.2	42.5	38.3	35.0	—	—	—	—	—	—	—	—	—	—	—	
30	45.5	38.6	—	—	—	—	—	—	—	—	—	—	—	—	—	

Note:
1. (kW) of Exposure Equals mA x kV.
For Example: 70 kV x 300 mA = 21 kW.
2. Exposures less than .010 seconds will have a kW rating same as .010 seconds.

Remarque:
1. (kW) en exposition égale kV x mA.
Par exemple: 70 kV x 300 mA = 21 kW.
2. Les expositions inférieures à 0.010 sec. ont les mêmes valeurs en kW que celles de 0.010 sec.

Anmerkungen:
1. (kW) der Belichtung ist gleich mA x kV.
Zum Beispiel: 70 kV x 300 mA = 21 kW.
2. Belichtungen von weniger als .010 Sekunden haben die gleichen kW Werte wie die von .010 Sekunden.

Nota:
1. (kW) De exposición se calcula multiplicando mA x kV-por ejemplo: 70 kV x 300 mA = 21 kW.
2. Para exposiciones de menos de .010 segundos, el resultado en (kW) sería lo mismo que el de .010 segundos.

Nominal anode input power for the anode heat content 70%. IEC 60613

Puissance calorifique nominale de l'anode: 70%, CEI 60613

Thermische Anodenbezugsleistung bei einer Wärmespeicherung von 70%. IEC 60613

Aproximadamente el poder de penetración para obtener un almacenaje de calor del anode de 70%. IEC 60613

1.0 Focal Spot 3Ø 10 Degrees 150180 Hz
1,0 Dimension Focale 3Ø 10 Degrés 150/180 Hz
1.0 Brennpunkt 3Ø 10 Grad 150/180 Hz
1.0 De Marcas Focales 3Ø 10 Grados 150/180 Hz

Caractéristiques Pour L'Angiographie CEI 60613
Angiographische Nennleistungen IEC 60613
Gradaciones Angiografica IEC 60613

EXPOSURE RATE PER SECOND	TUBE LOAD (kW) AS A FUNCTION OF THE EXPOSURE TIME (SEC.) OF THE INDIVIDUAL RADIOGRAPHS OF THE SERIES															NUMBER OF EXPOSURES IN SERIES
	0.010	0.020	0.030	0.040	0.050	0.060	0.080	0.100	0.120	0.140	0.160	0.180	0.200	0.225	0.250	
1	104.9	100.7	97.5	94.9	92.6	90.5	86.9	83.7	81.0	78.5	76.2	74.1	72.2	70.0	68.0	10
2	104.4	99.6	96.1	93.1	90.4	88.1	84.0	80.4	77.3	74.6	72.1	69.8	67.7	65.4	63.2	
3	103.8	98.6	94.7	91.4	88.5	85.9	81.4	77.5	74.2	71.2	68.6	66.2	—	—	—	
4	103.4	97.8	93.6	90.0	86.8	84.0	79.1	74.9	71.4	68.3	—	—	—	—	—	
8	101.8	95.1	89.8	85.4	81.6	78.3	—	—	—	—	—	—	—	—	—	
15	99.8	91.7	85.4	80.1	—	—	—	—	—	—	—	—	—	—	—	
30	97.3	87.4	—	—	—	—	—	—	—	—	—	—	—	—	—	
1	104.2	99.3	95.5	92.4	89.6	87.1	82.7	79.0	75.7	72.7	70.1	67.7	65.4	62.9	60.6	20
2	103.5	98.0	93.8	90.2	87.1	84.3	79.4	75.3	71.7	68.5	65.7	63.1	60.8	58.1	55.8	
3	102.8	96.8	92.1	88.2	84.8	81.7	76.5	72.0	68.2	64.9	62.0	59.3	—	—	—	
4	102.2	95.7	90.7	86.5	82.8	79.5	73.9	69.2	65.2	61.8	—	—	—	—	—	
8	100.1	92.2	86.0	80.9	76.5	72.7	—	—	—	—	—	—	—	—	—	
15	97.3	87.5	80.1	74.1	—	—	—	—	—	—	—	—	—	—	—	
30	93.1	81.0	—	—	—	—	—	—	—	—	—	—	—	—	—	
1	102.8	96.8	92.1	88.1	84.7	81.6	76.2	71.6	67.7	64.3	61.2	58.4	55.9	53.2	50.7	40
2	101.9	95.3	90.1	85.8	82.0	78.6	72.8	68.0	63.8	60.3	57.1	54.3	51.8	49.0	46.5	
3	101.1	93.9	88.3	83.6	79.5	75.9	69.8	64.8	60.5	56.9	53.7	50.9	—	—	—	
4	100.4	92.7	86.7	81.7	77.4	73.6	67.2	61.9	57.6	53.9	—	—	—	—	—	
8	97.9	88.6	81.4	75.5	70.5	66.3	—	—	—	—	—	—	—	—	—	
15	94.4	83.0	74.5	67.8	—	—	—	—	—	—	—	—	—	—	—	
30	88.9	74.9	—	—	—	—	—	—	—	—	—	—	—	—	—	
1	101.5	94.5	89.0	84.4	80.4	76.9	70.8	65.8	61.5	57.8	54.5	49.6	44.7	39.7	35.7	60
2	100.6	93.0	87.0	82.1	77.8	74.0	67.6	62.4	58.0	54.2	51.0	48.1	44.7	39.7	35.7	
3	99.7	91.5	85.2	79.9	75.3	71.4	64.8	59.4	54.9	51.2	47.9	45.1	—	—	—	
4	99.0	90.3	83.5	78.0	73.2	69.1	62.2	56.8	52.3	48.5	—	—	—	—	—	
8	96.3	85.9	78.0	71.7	66.4	61.9	—	—	—	—	—	—	—	—	—	
15	92.4	79.9	70.9	63.8	—	—	—	—	—	—	—	—	—	—	—	
30	86.3	71.2	—	—	—	—	—	—	—	—	—	—	—	—	—	
1	100.2	92.4	86.2	81.1	76.7	72.8	66.2	60.9	55.8	47.9	41.9	37.2	33.5	29.8	26.8	80
2	99.3	90.8	84.2	78.8	74.1	70.0	63.3	57.8	53.3	47.9	41.9	37.2	33.5	29.8	26.8	
3	98.4	89.4	82.4	76.6	71.7	67.5	60.6	55.1	50.5	46.7	41.9	37.2	—	—	—	
4	97.6	88.1	80.7	74.7	69.7	65.3	58.2	52.6	48.1	44.4	—	—	—	—	—	
8	94.8	83.6	75.2	68.5	63.0	58.4	—	—	—	—	—	—	—	—	—	
15	90.8	77.5	68.0	60.8	—	—	—	—	—	—	—	—	—	—	—	
30	84.2	68.5	—	—	—	—	—	—	—	—	—	—	—	—	—	
1	99.0	90.3	83.6	78.0	73.3	69.1	62.3	53.6	44.7	38.3	33.5	29.8	26.8	23.8	21.4	100
2	98.1	88.8	81.7	75.8	70.8	66.6	59.5	53.6	44.7	38.3	33.5	29.8	26.8	23.8	21.4	
3	97.2	87.3	79.8	73.7	68.6	64.2	57.0	51.4	44.7	38.3	33.5	29.8	—	—	—	
4	96.4	86.0	78.2	71.9	66.6	62.1	54.8	49.2	44.7	38.3	—	—	—	—	—	
8	93.5	81.5	72.7	65.8	60.2	55.5	—	—	—	—	—	—	—	—	—	
15	89.3	75.4	65.6	58.2	—	—	—	—	—	—	—	—	—	—	—	
30	82.6	66.3	—	—	—	—	—	—	—	—	—	—	—	—	—	
1	96.2	85.7	77.8	71.4	66.0	59.6	44.7	35.7	29.8	25.5	22.3	19.9	17.9	15.9	14.3	150
2	95.2	84.2	76.0	69.3	63.9	59.3	44.7	35.7	29.8	25.5	22.3	19.9	17.9	15.9	14.3	
3	94.3	82.8	74.2	67.4	61.9	57.3	44.7	35.7	29.8	25.5	22.3	19.9	—	—	—	
4	93.5	81.5	72.7	65.8	60.1	55.5	44.7	35.7	29.8	25.5	—	—	—	—	—	
8	90.5	77.1	67.5	60.2	54.4	49.7	—	—	—	—	—	—	—	—	—	
15	86.2	71.0	60.8	53.2	—	—	—	—	—	—	—	—	—	—	—	
30	79.2	62.0	—	—	—	—	—	—	—	—	—	—	—	—	—	

Note:
1. (kW) of Exposure Equals mA x kV.
For Example: 70 kV x 300 mA = 21 kW.
2. Exposures less than .010 seconds will have a kW rating same as .010 seconds.

Remarque:
1. (kW) en exposition égale kV x mA.
Par exemple: 70 kV x 300 mA = 21 kW.
2. Les expositions inférieures à 0.010 sec. ont les mêmes valeurs en kW que celles de 0.010 sec.

Anmerkungen:
1. (kW) der Belichtung ist gleich mA x kV.
Zum Beispiel: 70 kV x 300 mA = 21 kW.
2. Belichtungen von weniger als .010 Sekunden haben die gleichen kW Werte wie die von .010 Sekunden.

Nota:
1. (kW) De exposición se calcula multiplicando mA x kV por ejemplo: 70 kV x 300 mA = 21 kW.
2. Para exposiciones de menos de .010 segundos, el resultado en (kW) sería lo mismo que el de .010 segundos.

Nominal anode input power for the anode heat content 70%. IEC 60613

Puissance calorifique nominale de l'anode: 70%, CEI 60613

Thermische Anodenbezugsleistung bei einer Wärmespeicherung von 70%. IEC 60613

Aproximadamente el poder de penetración para obtener un almacenaje de calor del anodo de 70%. IEC 60613

Abaques d'Échauffement et de Refroidissement de L'Anode
Anode Aufheiz - und AbKühlkurven
Curvas de Calentamiento y Enfriamiento del Anodo

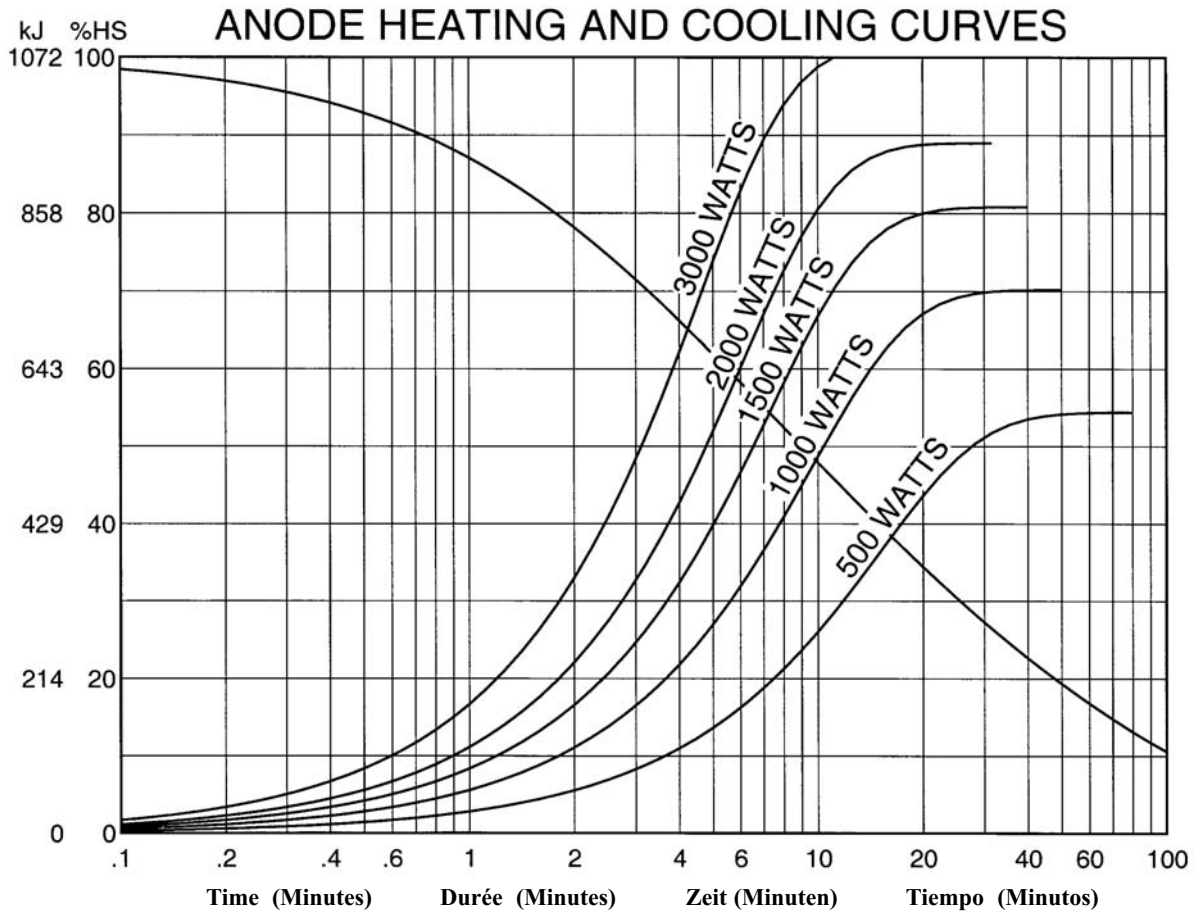

Note:
1. Heating and cooling curves reflect maximum tube performance. Tube operation is ultimately limited by system software control.

Remarque:
1. Les abaques d'échauffement et de refroidissement représentent des valeurs maximales. L'utilisation du tube est finalement limitée par le logiciel du système.

Anmerkungen:
1. Die Angaben stellen die höchstzulässigen Betriebswerte dar. Der technische Betrieb muß im Rahmen der Belastungs- und Abkühlkennlinien durchgeführt werden.

Nota:
1. El máximo poder del tubo es reflectada en el diagrama de enfriamiento y calentamiento del encaje ensamblado. La operación del tubo es ultimamente limitada por el control del sistema programado.